

Table of Contents

Introduction	1
Glossary	3
Configurations.....	4
<i>Description of Setup Keys</i>	<i>5</i>
Zone Control.....	6
<i>Zone Setup</i>	<i>6</i>
<i>Zone Operation.....</i>	<i>7</i>
Scene Control	8
<i>Scene Setup</i>	<i>9</i>
<i>Scene Operation</i>	<i>11</i>
<i>Scene Controller Conf command</i>	<i>11</i>
Additional Device Setup	12
<i>Add/Delete Devices</i>	<i>12</i>
<i>Assign Association for Two Devices.....</i>	<i>13</i>
<i>Definition of Association groups</i>	<i>15</i>
<i>Change Device Configuration</i>	<i>15</i>
<i>Add A Simple AV Device.....</i>	<i>16</i>
Advanced Z-Wave Network Setups.....	17
<i>Copying All Network and Device Information to A Secondary Controller</i>	<i>17</i>
<i>Copying Network Information to A Secondary Controller.....</i>	<i>18</i>
<i>Transferring All Network and Device Information to A New Primary Controller (Primary shift)</i>	<i>19</i>
<i>Transferring Only Network Information to A New Primary Controller (Primary shift).....</i>	<i>20</i>
<i>Replicating All Network and Device Information from A Primary Controller to your HSK-100Z (aka "Learning Mode")</i>	<i>21</i>
<i>Listening Mode.....</i>	<i>22</i>
<i>Resetting Your Network.....</i>	<i>23</i>
AUDIO/VIDEO SETUP AND OPERATION	24
<i>Description of Audio/Video Control Keys.....</i>	<i>25</i>
<i>AV Equipment Selection by Entering Device Code.</i>	<i>27</i>
<i>AV Equipment Selection by Searching through the Library</i>	<i>28</i>

<i>Learning IR Commands</i>	30
<i>Operating the HSK-100Z for AV Equipment</i>	31
ADVANCED OPERATION FOR AV EQUIPMENT ..	33
<i>Secondary Function</i>	33
<i>IR Boost Mode</i>	33
<i>Restore Factory Settings</i>	33
MAINTENANCE	34
FREQUENTLY ASKED QUESTIONS	34
<i>Z-Wave Frequently Asked Questions</i>	34
<i>AV Control Frequently Asked Questions</i>	35
TECHNICAL SPECIFICATIONS.....	36
WARRANTY.....	37
FEDERAL COMMUNICATION COMMISSION INTERFERENCE STATEMENT	37
WARNINGS.....	39

HSK-100Z

Z-Wave AV Scenario Controller

Introduction

The *HSK-100Z Z-Wave AV Scenario Controller* is a universal AV remote and also a Z-Wave controller (Figure 1). As a universal remote, the HSK-100Z replaces all your AV remotes through its built-in IR code database or IR code learning. As a Z-Wave controller, the HSK-100Z works with Z-Wave enabled devices and controls their on/off or up/down individually, as a Group, or via a pre-configured Scene.

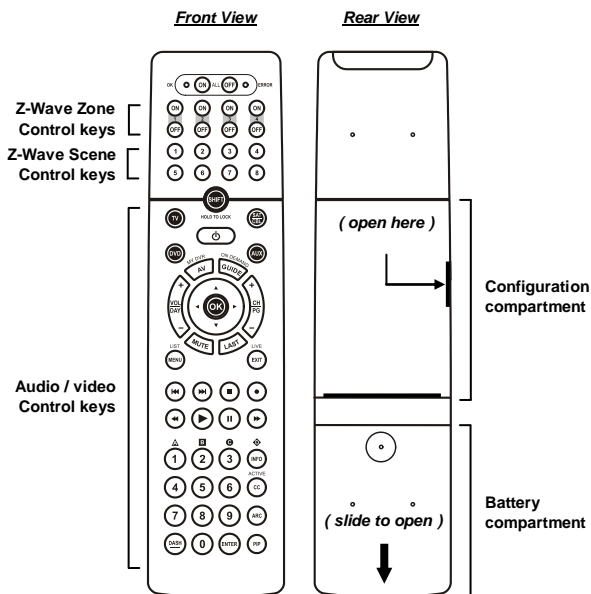

Figure 1 Outlook of the HSK-100Z

Please note that all Z-Wave devices, light switches, dimmers, and shutter switches made from various vendors are compatible with your HSK-100Z as long as they carry the Z-Wave logo:



Before using the HSK-100Z, please install the batteries:

- 3xAAA batteries are required for operation.
- Remove the battery cover on the back of your HSK-100Z.
- Check the polarity of the batteries and the "+/-" marks inside the battery compartment.
- Insert the batteries.
- Push the battery cover back in place.

ⓘ CAUTION (battery safety)

- Use new batteries of the recommended type and size only.
- Never mix used and new batteries together.
- To avoid chemical leaks, remove batteries from the HSK-100Z if you do not intend to use the remote for an extended period of time.
- Dispose of used batteries properly; do not burn or bury them.

Glossary

Device or Node	Z-Wave enabled device that can be controlled by the HSK-100Z.
Inclusion	Add a Z-Wave device to the network.
Exclusion	Delete a Z-Wave device from the network.
Remove	To take a device out of a group, scene or association group while that device still exists in the same Z-Wave network.
Z-Wave Network	A collection of Z-Wave devices controlled by primary and secondary controllers operating on the same system. A Z-Wave network has its own unique ID code so that controllers not in the network cannot control the system.
Primary Controller	The first controller used to set up your devices and network. Only the Primary Controller can be used to include or delete modules from a network. It is recommended that you mark the primary controller for each network for ease in modifying your network.
Secondary Controller	A controller containing network information about other modules within the network and is used for controlling devices. Secondary controllers are created from the Primary Controller and cannot include or delete modules to the network.
Inclusion Controller	A controller containing network information about other modules within the network and is used for controlling devices. Inclusion controllers are created from the Primary Controller in a SIS enabled Z-Wave network. Inclusion Controller has the ability to add and remove devices from the network.
Scene	A collection of Z-Wave devices configured to turn to a specific level, setting, mode, or perform an operation. Scenes are usually activated by a controller, timed event, or specific conditions.

Configurations

Please open the configuration compartment then you can see the HSK-100Z setup keys (Figure 2).

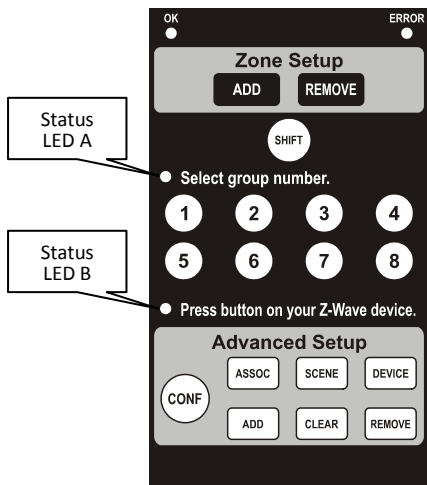











Figure 2 Setup Keys of the HSK-100Z

Description of Setup Keys

	<p>The ADD and REMOVE keys are used during basic Zone Setup process. ADD key will perform two functions:</p> <ul style="list-style-type: none">• Add a target device to Z-Wave network, also known as INCLUSION;• Add the device to the assigned GROUP. <p>REMOVE key will only remove the target device from its assigned group but will not exclude it from the network.</p>
	<p>This SHIFT key is used for accessing group numbers 9 to 16 while programming your devices.</p>
	<p>These are your group numbers 1 through 8 and also become group numbers 9 through 16 when combined with the SHIFT key.</p>
	<p>This CONFIGURATION key is used during the ADVANCED SETUP process.</p>
	<p>This ASSOCIATION key is used in conjunction with ADD, CLEAR or REMOVE keys in order to assign association groups.</p>
	<p>This SCENE key is used in conjunction with ADD, CLEAR or REMOVE keys in order to program scenes.</p>
	<p>This DEVICE key is used in conjunction with ADD, CLEAR or REMOVE keys in order to include or exclude devices to the network.</p>
	<p>This ADD key is used in the ADVANCED SETUP to:</p> <ul style="list-style-type: none">• Add a target device to the network (inclusion);• Add a target device to an association group;• Add a target device to a scene.
	<p>This CLEAR key is used in the ADVANCED SETUP to:</p> <ul style="list-style-type: none">• Delete a device from the network (exclusion);• Delete an association group;• Delete a scene.
	<p>This REMOVE key is used in the ADVANCED SETUP to:</p> <ul style="list-style-type: none">• Remove a device from an association group;• Remove a device from a scene.

For basic on/off or dim up/down control, please refer to Zone Control section. For more advanced setups including scene control, please refer to Advanced Setup section.

Zone Control

The HSK-100Z enables you to control single or multiple Z-Wave devices with the press of a button. For example, you can group all your bedroom lights together so that all of them will turn on with the press of a button.

You can control up to 8 zones with your HSK-100Z. Each zone supports up to 232 Z-Wave devices.

Zone Setup

Including Device to a Zone

Step	Setup Key	Setup LED Behavior
1	Press  in Zone Setup area	<ul style="list-style-type: none">• OK LED on• LED A blinks slowly
2	Select a zone group number from 1 to 8	<ul style="list-style-type: none">• LED A off• LED B blinks slowly
3	Press the program button on the target device	<ul style="list-style-type: none">• OK LED blinks once then turns off• LED B off• Zone setup completed

Note: If you cannot add your Z-Wave device, this device might have been included in another Z-Wave network. In this case, please delete this device following the steps in the [Deleting a Device from the Network] section then add this device again.

Removing Device from a Zone

Step	Setup Key	Setup LED Behavior
1	Press REMOVE in Zone Setup area	<ul style="list-style-type: none">• OK LED on• LED A blinks slowly
2	Select a zone group number from 1 to 8	<ul style="list-style-type: none">• LED A off• LED B blinks slowly
3	Press the program button on the target device	<ul style="list-style-type: none">• OK LED blinks once then turns off• Device been removed from the zone successfully

Note: If the ERROR LED turns on or blinks, meaning the setup process is failed. Please redo the process.

Zone Operation

After adding devices to your HSK-100Z using Zone Setup, you can turn the device on/off or up/down via the corresponding zone control keys in front (Figure3).

- For on/off switches, press **ON** key to turn on the devices and **OFF** key to turn them off.
- To operate dimmer switches and curtain motors, hold the **ON** key to open the curtain or dim up the light. By holding the **OFF** key you can retract the curtain or dim down the light.
- You can turn on all the devices in the network by pressing All On key and turn them off via All Off key.
- The green OK LED blinks when the operation is successful, and the red ERROR LED blinks when it's failed.

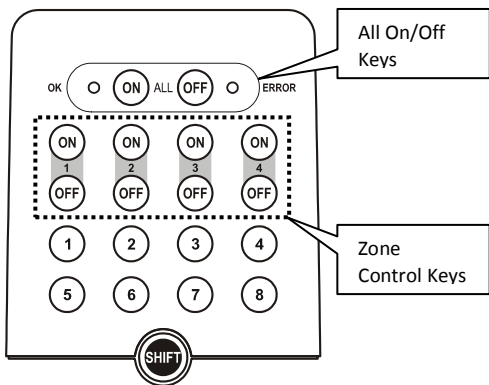

Figure 3 Zone Control Keys of the HSK-100Z



Scene Control

A Z-Wave Scene is a series of controlled events that work in unison for a planned task or home ambience. For example, you can setup a scene for “Watch DVD” where the scene button on the HSK-100Z could dim the lights and turn on your TV, DVD Player, and AV Receiver. A scene for “Arriving Home” could open the garage door, turn on the hall lights and disarm the security system. Z-Wave scenes are powerful tools for home control because they let simple user actions control multiple events.



The HSK-100Z allows you to setup 16 scenes. Each scene can involve up to 232 Z-Wave devices.

Scene Setup



Adding Device to A Scene

Step	Setup Key	Setup LED Behavior
1	Press 	The OK light turns on
2	Press 	<ul style="list-style-type: none">• OK LED blinks once and stays on LED A blinks slowly
3	Select a scene number from 1 to 16 (1-8 or SHIFT 1-8)	<ul style="list-style-type: none">• OK LED blinks once and stays on• LED A off• LED B blinks slowly
4	Press the program button on the target device	<ul style="list-style-type: none">• OK LED blinks once and stays on• LED B keep blinking slowly
5	Adjust the target device on/off or dim level with its program button, to the desired status	
6	Press 	<ul style="list-style-type: none">• OK LED blinks once then turns off• LED B off The current status of the device will be learned and saved to a scene successfully.

Removing Device from A Scene

Step	Setup Key	Setup LED Behavior
1	Press 	The OK light turns on
2	Press 	<ul style="list-style-type: none">• OK LED blinks once and stays on LED A blinks slowly
3	Select a scene number from 1 to 16 (1-8 or SHIFT 1-8)	<ul style="list-style-type: none">• OK LED blinks once and stays on• LED A off• LED B blinks slowly
4	Press the program button on the target device	<ul style="list-style-type: none">• the OK light stays on then flashes once and turns off• LED B off• Device removed from the scene successfully

Deleting A Scene

Step	Setup Key	Setup LED Behavior
1	Press 	The OK light turns on
2	Press 	<ul style="list-style-type: none">• OK LED blinks once and stays on• LED A blinks slowly
3	Select a scene number from 1 to 16 (1-8 or SHIFT 1-8)	<ul style="list-style-type: none">• OK LED blinks once then turns off• LED A off• Scene deleted from the scene successfully

Note: If the ERROR LED turns on or blinks, meaning the setup process is failed. Please redo the process.

Scene Operation

After the scene setup is done, you can trigger the desired scene via scene control keys in front panel of the HSK-100Z.

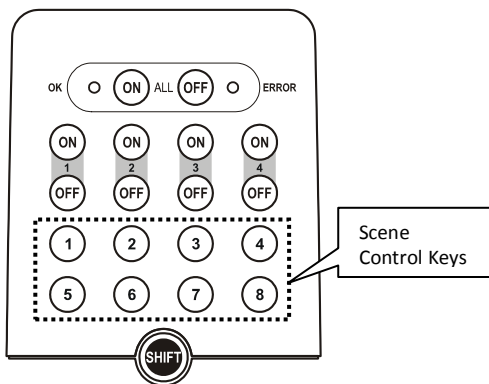

Figure 4 Scene Control Keys of the HSK-100Z

The green OK LED blinks when the operation is successful, and the red ERROR LED blinks when it's failed.

Scene Controller Conf command

This section is for advanced user. Please ignore it if you don't understand. It won't affect any normal usage before you send commands described in this section.

The command class `COMMAND_CLASS_ASSOCIATION` can be used to add a node to the scene button. The scene button 1 will send to devices in the group #9, the scene button 2 will send to group #10 and so on. The "ON" buttons 1-4 send `SCENE_ACTIVATION_SET` to devices in the group #1-4. "SHIFT + ON 1-4" send to devices in the group #5-8.

However, please notice that the scene created by this command is different from that created by the HSK-100 keypad. If we use this command to create a scene, the existing scenes created by the HSK-100Z will be deleted automatically. In addition, if we use HSK-100Z to assign a device to a scene button, the setting created by the `ASSOCIATION_SET` will be dropped as well.

In addition, we can use the `COMMAND_CLASS_SCENE_CONTROLLER_CONF` to change the scene ID for each button. However, if you have added a device to a scene button before, this command will not take effect.



Please remove the scene setting by using one of

- Clear scene in the HSK-100Z.
- Use `ASSOCIATION_SET` to add a device. In this case, all scenes created by the HSK-100Z will be cleared automatically.



Additional Device Setups

Add/Delete Devices

Adding Device to the Network

Step	Setup Key	Setup LED Behavior
1	Press  (in Advanced Setup)	The OK light turns on
2	Press 	<ul style="list-style-type: none"> • OK LED blinks once and stays on LED B blinks slowly
3	Press the program button on the target device	<ul style="list-style-type: none"> • OK LED blinks once then turns off • LED B off • Device inclusion completed



Deleting Device from the Network

Step	Setup Key	Setup LED Behavior
1	Press 	The OK light turns on
2	Press 	<ul style="list-style-type: none"> • OK LED blinks once and stays on LED B blinks slowly
3	Press the program button on the target device	<ul style="list-style-type: none"> • OK LED blinks once then turns off • LED B off • Device exclusion completed



Assign Association for Two Devices

The HSK-100Z can be used to assign one device to automatically interact directly with another device. For example you can assign a door sensor (primary node) to turn on the light switch (secondary node) when the door is opened.



Assigning Association

Step	Setup Key	Setup LED Behavior
1	Press  (in Advanced Setup)	The OK light turns on
2	Press 	<ul style="list-style-type: none">• OK LED blinks once and stays on LED A blinks slowly
3	Select a group number from 1 to 16 (1-8 or SHIFT 1-8)	<ul style="list-style-type: none">• OK LED blinks once and stays on• LED A off• LED B blinks slowly
4	Press the program button on the secondary node	<ul style="list-style-type: none">• OK LED blinks once and stays on• LED B blinks once and keep blinking slowly
5	Press the program button on the primary device	<ul style="list-style-type: none">• LED B turns off• OK LED blinks once then turns off• Assigning association completed

Removing Device from Association

Step	Setup Key	Setup LED Behavior
1	Press 	The OK light turns on
2	Press 	<ul style="list-style-type: none">• OK LED blinks once and stays on LED A blinks slowly
3	Select a group number from 1 to 16 (1-8 or SHIFT 1-8)	<ul style="list-style-type: none">• OK LED blinks once and stays on• LED A off• LED B blinks slowly
4	Press the program button on the secondary node	<ul style="list-style-type: none">• OK LED blinks once and stays on• LED B blinks once and keep blinking slowly
5	Press the program button on the primary device	<ul style="list-style-type: none">• LED B turns off• OK LED blinks once then turns off• Device removed from the association group successfully

Deleting an Association Group

Step	Setup Key	Setup LED Behavior
1	Press 	The OK light turns on
2	Press 	<ul style="list-style-type: none">• OK LED blinks once and stays on LED A blinks slowly
3	Select a group number from 1 to 16 (1-8 or SHIFT 1-8)	<ul style="list-style-type: none">• OK LED blinks once and stays on• LED A off• LED B blinks slowly
4	Press the program button on the primary device	<ul style="list-style-type: none">• LED B turns off• OK LED blinks once then turns off• Deleting the association group successfully

Definition of Association groups

The HSK-100Z supports 24 association groups. Each group can support up to 232 devices.

Group	Function
1-8	Zone Control #1-#8
9-24	Scene Control #1-#16

Change Device Configuration

This function is used to modify the parameter of the Z-Wave device via the configuration command class. This is possible only when the HSK-100Z is primary controller or inclusion controller.

Step	Setup Key	Setup LED Behavior
1	Press 	OK LED stays on
2	Press 0-9 key in the front	<ul style="list-style-type: none">• OK LED blinks once and stays on for each key press
3	Press enter	<ul style="list-style-type: none">• OK LED stays on then flashes once and turns off• LED B off• The input number is the parameter number.
4	Press 0-9 key	<ul style="list-style-type: none">• OK LED blinks once and stays on for each key press
5	Press enter	<ul style="list-style-type: none">• OK LED blinks once and then keeps blinking.• The input number is the configuration value.
6	Press the program button in the device.	<ul style="list-style-type: none">• OK LED blinks and turns off.• The configuration value is saved to the device.

Add A Simple AV Device

The HSK-100Z supports the Simple AV Control command class to control Z-Wave Simple AV devices. It can support up to 8 channels with different Z-Wave AV devices. To change to different AV channels, press each corresponding AV device mode key.

Channel	Mode Key
1	TV
2	DVD
3	SAT/CBL
4	AUX
5	Shift+TV
6	Shift+DVD
7	Shift+SAT/CBL
8	Shift+AUX

To add a Z-Wave Simple AV device to HSK-100Z, please follow these steps:

Step	Setup Key	Setup LED Behavior
1	Press ADD in Zone Setup area	<ul style="list-style-type: none">• OK LED on• LED A blinks slowly
2	Press Shift	<ul style="list-style-type: none">• OK LED blink
3	Select a zone group number from 1 to 8	<ul style="list-style-type: none">• LED A off• LED B blinks slowly• This will select device AV channel 1-8.
4	Press the program button on the target device	<ul style="list-style-type: none">• OK LED blinks for a while and then turns off.

If a channel is associated with Z-wave Simple AV devices, the local IR transmission of that channel will be disabled. Instead, the Simple AV commands will be sent to the associated Z-wave devices.

To recover to local IR emitter, please remove the Z-Wave AV device using the following steps:

Step	Setup Key	Setup LED Behavior
1	Press REMOVE in Zone Setup area	<ul style="list-style-type: none">• OK LED on• LED A blinks slowly
2	Press Shift	<ul style="list-style-type: none">• OK LED blink
3	Select a zone group number from 1 to 8. Press 1 here.	<ul style="list-style-type: none">• LED A off• LED B blinks slowly• This will select device AV channel 1-8.
4	Press the program button on the target device	<ul style="list-style-type: none">• OK LED blinks for a while and then turns off.

Advanced Z-Wave Network Setups

Copying All Network and Device Information to A Secondary Controller



You can add a secondary controller to your network and copy all of your HSK-100's network and device information to the secondary controller by following the steps below.

Step	Setup Key	Setup LED Behavior
1	Press & hold  for 3 seconds	OK LED on
2	Place the two controller close to each other	
3	Type "8541" on the setup number keypad	<ul style="list-style-type: none">• OK LED blinks once for each number input• OK LED keeps blinking after entering the 4-digit
4	Please make sure the target controller is setup to receive information. (Refer to the target controller user manual for more information)	<ul style="list-style-type: none">• OK LED blinks once then turns off• Replication completed

Note: If the replication is unsuccessful, the OK light turns off and the error light will flash 6 times then turn off.



Copying Network Information to A Secondary Controller

You can add a secondary controller to your network and copy all of your primary controller's network information to the secondary controller by following the steps below.

Step	Setup Key	Setup LED Behavior
1	Press & hold   for 3 seconds	OK LED on
2	Place the two controller close to each other	
3	Type "8542" on the setup number keypad	<ul style="list-style-type: none">• OK LED blinks once for each number input• OK LED keeps blinking after entering the 4-digit
4	Please make sure the target controller is setup to receive information. (Refer to the target controller user manual for more information)	<ul style="list-style-type: none">• OK LED blinks once then turns off• Replication completed

Transferring All Network and Device Information to A New Primary Controller (Primary Shift)

You can transfer all of your controller information to another remote so that it will become the new primary remote. This is done by following the steps below.

Step	Setup Key	Setup LED Behavior
1	Press & hold   for 3 seconds	OK LED on
2	Place the two controller close to each other	
3	Type "8361" on the setup number keypad	<ul style="list-style-type: none">• OK LED blinks once for each number input• OK LED keeps blinking after entering the 4-digit
4	Please make sure the target controller is setup to receive information. (Refer to the target controller user manual for more information)	<ul style="list-style-type: none">• OK LED blinks once then turns off• Replication completed

Transferring Only Network Information to A New Primary Controller (Primary Shift)

You can just transfer network information to another remote so that it will become the new primary remote. This is done by following the steps below.

Step	Setup Key	Setup LED Behavior
1	Press & hold  for 3 seconds	OK LED on
2	Place the two controller close to each other	
3	Type "8362" on the setup number keypad	<ul style="list-style-type: none">• OK LED blinks once for each number input• OK LED keeps blinking after entering the 4-digit
4	Please make sure the target controller is setup to receive information. (Refer to the target controller user manual for more information)	<ul style="list-style-type: none">• OK LED blinks once then turns off• Replication completed

Replicating All Network and Device Information from A Primary Controller to Your HSK-100Z (aka “Learning Mode”)

Your HSK-100Z can:

- Copy the settings from another Z-Wave controller
- Be included into existing Z-Wave network and become a new primary or secondary remote
- Be excluded from the Z-Wave network

by following the steps below.

Step	Setup Key	Setup LED Behavior
1	Press & hold  for 3 seconds	OK LED on
2	Place the two controller close to each other	
3	Type “8363” on the setup number keypad	<ul style="list-style-type: none">• OK LED blinks once for each number input
4	Please make sure the primary controller is setup to send information. (Refer to the primary controller user manual for more information)	<ul style="list-style-type: none">• OK LED blinking then turns off• Replication completed

Note: If the replication is unsuccessful, the OK light turns off and the error light will flash 6 times then turn off.

Listening Mode

There are multiple usages by entering this mode:

- Version command class: To get application software version, the Z-Wave protocol version and the supported Z-Wave command version of this controller.
- Manufacturer command class: To get the manufacture ID, product type ID and the product ID of this controller.
- Scene configuration command class: Home gateway can bundle a scene ID to a group ID using this command.
- Association command class: To create and maintain associations in this remote.

Step	Setup Key	Setup LED Behavior
1	Press & hold  for 3 seconds	OK LED on
2	Place the two controller close to each other	
3	Type "8364" on the setup number keypad	<ul style="list-style-type: none">• OK LED blinks once for each number input• OK LED keeps blinking after entering the 4-digit
4	Listening mode will automatically exit after 1 minute of inactivity	<ul style="list-style-type: none">• OK LED blinks once then turns off when exiting listening mode• Replication completed

Note: The mode must not be exited during communication process with another controller. Please wait for entire communication process to be completed.

Resetting Your Network

You can reset your HSK-100Z to clear all Z-Wave network and device information by the following steps:

Step	Setup Key	Setup LED Behavior
1	Press & hold  for 3 seconds	OK LED on
2	Place the two controller close to each other	
3	Type "8761" on the setup number keypad	<ul style="list-style-type: none">• OK LED blinks once for each number input• OK LED on after entering the 4-digit
4		<ul style="list-style-type: none">• OK LED blinking then turns off• Reset completed

Note 1: If the reset is unsuccessful, the OK light turns off and the error light will flash 6 times then turn off.

Note 2: After reset the remote, each device should individually perform in the section on "Delete device from the network" and "Add device to the network"

AUDIO/VIDEO SETUP AND OPERATION

In addition to Z-Wave device and scene control, your HSK-100Z is also a universal remote which enables you to control all your audio/video systems around your house.

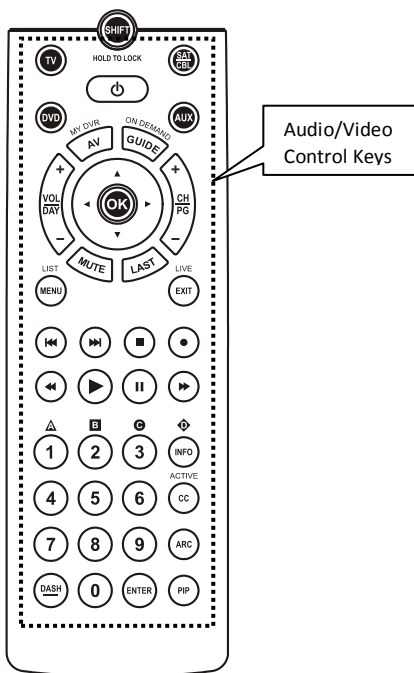













Figure 5 Audio/Video Control Keys of the HSK-100Z















Note: The audio/video control of the HSK-100Z can be done via infrared or Z-Wave. HSK-200Z Z-Wave IR Control Station is needed for Z-Wave based AV control. Please refer to the user manual of the HSK-200Z for details. Other AV equipments that support the Z-Wave Simple AV Control Command Class can be used as the IR extender as well.





Description of Audio/Video Control Keys

The HSK-100Z operates up to 8 AV equipments which are accessed by using the SHIFT key and TV or DVD and so on.

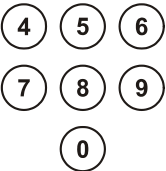
Note: The SHIFT key is used when operating both the AV and Z-Wave equipments

	<p>Press once to access secondary function for the next button. Press and hold to activate shift lock for permanent use of secondary functions. Press shift again to release shift lock</p>
	<p>Selects TV mode</p>
	<p>Selects satellite, cable receiver or similar devices such as DVB-T, IPTV, etc.</p>
	<p>On/off key for selected AV equipment</p>
	<p>Selects DVD player or other optical disc players such as Blue Ray, PVR, or CD player</p>
	<p>Selects Auxiliary mode normally assigned to audio equipment</p>
	<p>Scrolls through AV modes while in TV mode; also my DVR when in shift mode</p>
	<p>Selects guide while in SAT/CBL mode; also on demand when in shift mode</p>
	<p>Changes volume level of the device; also in shift mode changes the day when operating your SAT/CBL device</p>
	<p>Changes the channels when in TV, DVR, or SAT/CBL mode; also in shift mode changes the page number while operating your SAT/CBL device</p>
	<p>Mute the audio</p>
	<p>Return to the previous channel</p>

	<p>4-way directional pad for navigating on-screen menu and OK button for selecting menu options</p>
<p>LIST</p> 	<p>Menu, also list when in shift mode</p>
<p>LIVE</p> 	<p>Exit, also Live for SAT/CBL mode when in shift mode</p>
	<p>Previous track</p>
	<p>Next track</p>
	<p>Stop</p>
	<p>Record</p>
	<p>Rewind</p>
	<p>Play</p>
	<p>Pause</p>
	<p>Fast forward</p>
<p>▲</p> 	<p>Numeric number 1; also in shift mode can be either triangle/A or yellow button for TV or SAT/CBL menus</p>
<p>■</p> 	<p>Numeric number 2; also in shift mode can be either square/B or blue button for TV or SAT/CBL menus</p>
<p>●</p> 	<p>Numeric number 3; also in shift mode can be either circle/C or red button for TV or SAT/CBL menus</p>
	<p>Numeric numbers 4,5,6,7,8,9,0</p>

	Info while in SAT/CBL or TV mode; also in shift mode will be diamond/D or green button for TV or SAT/CBL menus
	Closed caption for teletext; also Active when in shift mode
	Aspect ratio control
	Activates picture in picture mode
	Dash for HDTV

AV Equipment Selection by Entering Device Code

You may setup the HSK-100Z by following the code entering instructions:

1. Referring to the DEVICE CODE LIST, look up the 4-digit Device Code which corresponds to the brand of your A/V equipment. If there is more than one Device Code listed under your brand, start from the first code.
2. Press the desired Device Mode Key (e.g. TV).
3. Hold down "CH +" and "VOL -" on the HSK-100Z simultaneously for 3 seconds until the green indicator lights up.
4. Use the number keys "0" - "9" to enter your 4-digit Device Code. The indicator flashes twice then goes out.

Turn on your device (e.g. TV), then try the function keys on the HSK-100Z. If your device (e.g. TV) responds to your activated function correctly, you have entered the right Device Code. Otherwise, repeat the above steps with the next available Device Codes until your device (e.g. TV) responds to your activated function, and most keys work correctly.

- Simply repeat the above procedures to enter the Device Codes for your SAT/CBL, DVD or AUX. (Remember to press the correct Device Mode Key in step 2 above)

Note: If the red indicator flashes 6 times in step 4, a wrong Device Code has been entered. You are required to repeat step 2 to 4 again.

Suggestions:

- If you cannot find a correct Device Code for your equipment, refer to *AV Equipment Selection by Searching through the Library*.
- For future reference you are recommended to take note of your Devices codes in the space provided in the manual after setting up the HSK-100Z correctly.

AV Equipment Selection by Searching through the Library

If you cannot identify a correct Device Code for your equipment from the Device Code list, you may search for the code in the library:-

1. Turn on your device manually (e.g. TV).
2. Press a desired Device Mode Key (e.g. TV).
3. Hold down "CH +" and "VOL -" on the HSK-100Z simultaneously for 3 seconds until the indicator lights up.
4. Enter a corresponding Magic Search Code from the following table. The green indicator flashes twice then goes out.





Device to be searched from code library	Magic Search Code
TV	0001
VCR/DVR/LASER DISC	0002
SAT	0003
CABLE / DVR+CABLE COMBOS	0004
DVD/DVD-R/RW/DVR+DVD COMBOS	0005
AUDIO	0006
CD	0007
HOME AUTOMATION	0008

(e.g. press "TV" device mode key, then press "CH +" and "VOL -", and enter TV Magic Search Code 0001.)



5. Press the same desired device mode key again as in step 2 above. (e.g. TV)
6. Hold down "CH +" & "VOL -" simultaneously for 3 seconds until the green indicator lights up, and your HSK-100Z is ready to start searching.
7. Aim the HSK-100Z at your device (e.g. TV), press the  key slowly and repeatedly until the device has been turned off. Once your device has been turned off, immediately press Device Mode Key (e.g. TV) to lock in code and the indicator should go out.

- * Simply repeat the above setup procedures to search for the Device Code for SAT/CBL, DVD or AUX. (Remember to press the correct Device Mode Key and correct Magic Search Code in step 2-5 above)

① IMPORTANT

- If the power on/off function of your device is not infra-red controlled, you need to follow steps 2 to 6 above and start searching.
 - Press  and another function key alternately until your device responds to the expected function, then press the same Device Mode Key (e.g. TV) to lock in the code.
- e.g. Press  &  alternately, or ;
- Press  &  alternately.

Notes:

- *TV, VCR, DVD, CTV and other device codes can be searched for and locked into any device modes. Simply press the corresponding device mode key in step 2 & 5 and enter an appropriate Magic Search Code for your DVD, CTV and other devices.*
- *Each time you press the , the HSK-100Z will skip to the next code and send out a POWER signal trying to turn off your device.*
- *If you fail to stop pressing  when your device has been turned off, turn your device on again immediately. Before the green indicator goes out, press "Mute" on the HSK-100Z to skip backward. Repeat step 7 above and lock in the code.*
- *If the red indicator flashes six times after your pressing of  key, you are already at the last code of the library. Press "CH +" and "VOL -" to resume the HSK-100Z and repeat the above procedures carefully to search again.*

Learning IR Commands

Your HSK-100Z is equipped with learning capability. This allows you to "teach" your HSK-100Z certain functions from your original equipment remote. Please follow the steps below.

- 1 Press the desired device mode key (e.g. TV).
- 2 Hold down "CH+" and "VOL-" on the HSK-100Z simultaneously for 3 seconds until the green indicator lights up.
- 3 Enter the learning code "0", "0", "0", "0". The green indicator light will flash once then stay lit. The HSK-100Z is now ready to learn.
- 4 Place the HSK-100Z and your device remote on a flat surface, aimed at each other 1-3 inches apart.
- 5 Press a desired key once and release on the HSK-100Z which you want to learn the command. The green indicator will flash once then stay lit.
- 6 Press and keep holding the key on your original equipment remote which you want to learn for a few seconds.
- 7 When the green indicator light flashes twice and stays lit continuously, the command has been learned successfully and you can release the key on your original equipment remote. If the red indicator light flashes six times, it shows an error in the learning process. Adjust the position of both remotes and repeat from step 5 again.
- 8 Repeat from step 5 to learn other key functions, or press the same device mode key on step 1 (e.g.TV) to terminate the learning mode, the green indicator light will flash twice and then go out immediately.

Notes:

- On step 5 if no key is selected for more than 8 seconds, the red indicator light will flash six times and the learning mode will exit automatically.
- On step 6, if no other remote signal is received for more than 8 seconds, the red indicator light flashes six times and stays lit continuously, you need to select a desired key again for learning as in step 5 on your HSK-100Z.
- Each function key will hold one command only, a new command to be learned will automatically erase and replace the previous one.
- If the green indicator light flashes six times during the transference of signals, the maximum of 100 commands memory bank is full, press the same device key again to resume normal operation.
- All device mode keys, as well as the SHIFT keys cannot be used for learning functions.

Operating the HSK-100Z for AV Equipment

Normal Operation

Once you have setup the HSK-100Z for your AV equipment, it works like your original remote control. To operate, just aim it at your equipment, press an appropriate device mode key and invoke the desired function by pressing a corresponding key on the HSK-100Z. The green indicator turns on during signal transmission and as Confirmation of key touch.

Punch Through

Punch Through Channel

Punch through channel allows you to operate channel up and down without having to switch the device modes repeatedly even when your HSK-100Z is in other operating modes.

To activate the punch through channel setting:

1. Press desired Device Mode Key (e.g. TV).
2. Press and Hold "CH+" key.
3. While still holding the "CH+" key press desired Device Mode Key (e.g. SAT).
4. Release "CH+" and the green indicator flashes once, now by pressing the "CH+" key while in TV mode the remote will act as if pressing the "CH+" key in SAT mode

To deactivate the punch through channel setting:

1. Press desired Device Mode Key (e.g. TV).
2. Press and Hold "CH -" key.

3. While still holding the "CH-" key press desired Device Mode Key (e.g. SAT).
4. Release "CH -" (the green indicator flashes twice if the setting is deactivated).

Punch Through Volume

Punch through volume allows you to operate volume up and down without having to switch the device modes repeatedly even when your HSK-100Z is in other operating modes.

To activate the punch through volume setting:

1. Press desired Device Mode Key (e.g. TV).
2. Press and Hold "VOL+" key.
3. While still holding the "VOL+" key press desired Device Mode Key (e.g. SAT).
4. Release "VOL+" and the green indicator flashes once, now by pressing the "VOL+" key while in TV mode the remote will act as if pressing the "VOL+" key in SAT mode



To deactivate the punch through volume setting:

1. Press desired Device Mode Key (e.g. TV).
2. Press and Hold "VOL -" key.
3. While still holding the "VOL-" key press desired Device Mode Key (e.g. SAT).
4. Release "VOL -" (the green indicator flashes twice if the setting is deactivated).

Macro Power

Macro Power allows you to turn two of your A/V equipment on/off simultaneously.

To activate the macro power setting:

1. Press desired Device Mode Key (e.g. TV).
2. Press and Hold  key.
3. Press desired Device Mode Key (e.g. SAT).
4. Release  (the green indicator flashes once if the setting is activated).

To deactivate the macro power setting:

1. Press desired Device Mode Key (e.g. TV).
2. Press and Hold  key.
3. Press desired Device Mode Key (e.g. SAT).

4. Release  (the green indicator flashes twice if the setting is deactivated).

ADVANCED OPERATION FOR AV EQUIPMENT

Secondary Function

- 1 Some keys are able to access 2 functions through the use of the shift key.
- 2 To use a buttons secondary function, press the shift key then the next button pressed will perform its secondary function after which the buttons will return to their primary functions.
- 3 You can access the shift lock mode by pressing and holding the shift key for 3 seconds after which all buttons pressed will use their secondary function. Pressing the shift key again will end the shift lock mode.

IR Boost Mode

By activating the boost switch in the battery compartment your HSK-100Z will send out 3 IR beams instead of 1 IR beam. Effectively tripling the power of your IR signal

Note: The range of your IR beam along with the angles will be increased but will also consume more power from the batteries.

Restore Factory Settings

- 1 Hold down "CH+" and "VOL-" keys on the remote simultaneously for 3 seconds until you the indicator lights up and stays lit.
- 2 Enter the reset code "9", "9", "9", "9". The indicator light goes out immediately. All settings are now restored to the factory default setting.

MAINTENANCE

- 1 Do not expose your HSK-100Z to dust, strong sunlight, humidity, high temperatures or mechanical shocks.
- 2 Do not use old and new batteries together as old batteries tend to leak.
- 3 Do not use corrosive or abrasive cleansers on your HSK-100Z.
- 4 Keep the unit dust free by wiping it with a soft, dry cloth.
- 5 Do not disassemble your HSK-100Z, it contains no user-serviceable parts.

FREQUENTLY ASKED QUESTIONS

Z-Wave Frequently Asked Questions

- Q Why won't my HSK-100Z work with the Z-Wave devices I purchased from another country?**
- A Due to different countries regulations Z-Wave products from different regions are set to different frequencies. Before purchasing new devices make sure you have checked to see that the device is compatible in your region.
- Q Do I need an electrician to install Z-Wave products in my house?**
- A Installation can be simple. In some cases all you need to do is attach the Z-Wave plug in module into the wall socket. For more advanced in-wall modules you may need this done by a qualified technician.
- Q What kinds of devices can I control with Z-Wave technology?**
- A While the Z-Wave device range is ever growing you can currently control your lighting, window shades and electric appliance which requires on/off switch with the HSK-100Z. In addition advanced models will be able to control additional devices such as thermostats.
- Q What can the HSK-100Z do for me?**
- A The HSK-100Z can control a combination of up to 232 different Z-Wave devices in 8 zones or 16 scenes around your house while also being a standard universal remote that can control up to 8 AV equipments. Your HSK-100Z truly turns your living room into your whole houses control station.

Q Why do I need a different module for outdoor lighting?

A The outdoor module is designed to withstand various weather conditions including heat, rain and snow.

Q Can I use 2 or more HSK-100Z controllers in my house at one time?

A You can use multiple HSK-100Z around your house by assigning one remote to be the primary remote and have an additional secondary controller.

Q If I lost my HSK-100Z will I also lose my settings?

A Yes and no, if you lose your primary HSK-100Z you will need to add all the Z-Wave devices to your new primary remote again. If you lose the secondary one you can replicate all the Z-Wave setup information from your primary remote onto a new secondary remote. However, audio visual settings will be lost and can not be replicated such as TV and DVD settings.

Q Where can I keep up to date with the latest Z-Wave products?

A You can get the latest information about Z-Wave by visiting the www.z-wave.com.

Q How do I know which product is compatible to my HSK-100Z remote?

A You can check either the specifications in the manual of your target device. All Z-Wave products also come with the Z-Wave logo



Q Can the HSK-100Z also operate Zigbee products?

A The HSK-100Z is currently not compatible with any Zigbee product.

AV Control Frequently Asked Questions

Q. My HSK-100Z does not work at all!

- A. Check your A/V device, if the device's main switch is turned off, your HSK-100Z cannot operate your device.
- A. Check whether your batteries are inserted properly and are in the correct +/- position.
- A. Check whether you have pressed the corresponding device mode key for your device.
- A. If the batteries are low, replace the batteries.

Q. If several Device Codes are listed under the brand of my A/V device, how can I select the correct Device Code?

A. To seek the correct Device Code for your A/V device, test the codes one by one until most keys work properly.

Q. My A/V equipment responds only to some of the commands.

A. You have set a code for which only some commands work properly but some do not. Try other codes until most keys work properly. You can also use the learning function to learn additional keys.

TECHNICAL SPECIFICATIONS

RF Frequency	908.42MHz (US)
IR Frequency	Up to 455KHz
IR Learning	Max 100 commands
Max. Range	up to 100ft indoor line of sight, in unobstructed environment
Power	AAA x 3pcs
Temperature	operation: 0~40°C storage: -20~60°C
Humidity	10~85%, non-condensing
Dimension (LxWxH)	240mm x 60mm x 29mm
Weight (ex. Batteries)	150g
Certifications	CE, FCC, RoHS, Z-Wave

WARRANTY

Limited One (1) Year Warranty

This warranty does not cover or apply to:

(a) damage to the product due to misuse, mishandling, and abuse, (b) products not used in accordance with manufacturer's instructions or recommendations, (c) product not assembled or installed according to manufacturer's instructions, (d) normal wear and tear, (e) wearing of the cover do to improper installation of cover and goods (f) damage to the contents of the shelter, (g) permits required due to zoning issues, (h) damage that has occurred during shipping, (i) acts of God. In addition consequential damage and incidental damages, such as damage to persons or property are not coverable under this warranty, and you should refer to your homeowner's insurance policy as with any other outside structure. Note: Some states do not allow the exclusion or limitation of certain damages, and in those cases these limitations do not apply.



FEDERAL COMMUNICATION COMMISSION INTERFERENCE STATEMENT

This equipment has been tested and found to comply with the limits for a Class B digital device, pursuant to Part 15 of the FCC Rules. These limits are designed to provide reasonable protection against harmful interference in a residential installation. This equipment generates, uses and can radiate radio frequency energy and, if not installed and used in accordance with the instructions, may cause harmful interference to radio communications. However, there is no guarantee that interference will not occur in a particular installation. If this equipment does cause harmful interference to radio or television reception, which can be determined by turning the equipment off and on, the user is encouraged to try to correct the interference by one of the following measures:

- Reorient or relocate the receiving antenna.
- Increase the separation between the equipment and receiver.

- Connect the equipment into an outlet on a circuit different from that to which the receiver is connected.
- Consult the dealer or an experienced radio/TV technician for help.

FCC Conditions

This device complies with Part 15 of the FCC Rules. Operation is subject to the following two conditions:

- (1) This device may not cause harmful interference.
- (2) This device must accept any interference received, including interference that may cause undesired operation.

FCC Caution: Any changes or modifications not expressly approved by the party responsible for compliance could void the user's authority to operate this equipment.

This transmitter must not be co-located or operating in conjunction with any other antenna or transmitter.

WARNINGS

- Do not dispose of electrical appliances as unsorted municipal waste, use separate collection facilities.
- Contact your local government for information regarding the collection systems available.
- If electrical appliances are disposed of in landfills or dumps, hazardous substances can leak into the groundwater and get into the food chain, damaging your health and well-being.

When replacing old appliances with new once, the retailer is legally obligated to take back your old appliance for disposal at least for free of charge.

Changes or modifications not expressly approved by the party responsible for compliance could void the user's authority to operate the equipment.

- **RISK OF FIRE**
- **RISK OF ELECTRICAL SHOCK**
- **RISK OF BURNS**

Exercise extreme caution when using Z-Wave devices to control appliances. Operation of the Z-Wave device may be in a different room than the controlled appliances, also an unintentional activation may occur if the wrong button on the remote is pressed. Z-Wave devices may automatically be powered on due to timed event programming. Depending upon the appliance, these unattended or unintentional operations could possibly result in a hazardous condition. For these reasons we recommend the following:

1. Assign Z-Wave controlled appliances to group number 5 to 8 on the HSK-100Z as the likelihood of unintentionally turning on of the appliance will be reduced significantly because the "SHIFT" button is also needed to activate groups 5 through 8.
2. Do not include Z-Wave devices controlling appliances in your group and scene settings.
3. Do not include Z-Wave devices to control electric heaters or other appliances which may present a hazardous condition due to an unattended or unintentional or automatic power on control.